

Digital Filter+

**Digital Filter Plus
User's Guide**

Version 2.50

3 January, 2015

© 2014 Numerix Ltd.
Email : <mailto:numerix@numerix-dsp.com>
WWW : <http://www.numerix-dsp.com/>



INTRODUCTION	3
INSTALLATION	4
USING DIGITAL FILTER PLUS	5
Starting Digital Filter Plus	5
The Main Digital Filter Plus Design Window	7
Digital Filter Plus Projects And Files	8
Toolbar And Menu Options	9
Designing Finite Impulse Response - Transversal Digital Filters	11
Designing Finite Impulse Response - Transversal Digital Filters	11
Introduction	11
FIR - Windowing	11
FIR - Remez Exchange Algorithm	11
FIR - Design Algorithms :	13
Designing Infinite Impulse Response - Biquad Digital Filter	14
Introduction	14
IIR - Pole-zero Placement	15
IIR - Traditional Filter Design	15
IIR – Design Algorithms	17
REGISTRATION	19
TECHNICAL SUPPORT	19

Introduction

Digital Filter Plus is an FIR and IIR digital filter design program that supports the following design algorithms :

Finite Impulse Response Filters

- Windowing
- Remez exchange algorithm
- Hilbert transformers
- Raised cosine and square root raised cosine
- Gaussian filter

Infinite Impulse Response Filters

- Pole / zero placement
- Traditional algorithms :
 - Butterworth
 - Chebyshev
 - Inverse Chebyshev
 - Elliptic
 - Bessel
 - Bilinear transform
 - Matched z-transform
- Notch filter

When each type of filter is selected the design entry boxes will be enabled or disabled (greyed out) as appropriate so that you only need to fill in the information that is enabled in order to be able to design your filter.

The basic mode of operation of Digital Filter Plus is to select the filter and project type from the dialog before entering the filter parameters on the left hand side of the main Digital Filter Plus window. Once the filter parameters have been entered, the "calculate" button, located on the bottom left hand side, should be clicked; this will calculate the filter coefficients and save them in a file, from where they can be viewed using the "View" menu option. If a filter project has not been calculated then the coefficients can not be viewed.

When using Digital Filter Plus for the first time, the application window may not show the entire application screen, it can however be re-sized to suit. The size and position will then be saved, automatically, so that the next time Digital Filter Plus is run it will have the same appearance.

Installation

To install Digital Filter Plus under Windows, please extract the .zip file into a suitable directory e.g. : *C:\Program Files\Numerix\DFPlus*. The directory can then be placed in the path or a shortcut can be created to the executable program (dfplus.exe)..

To install Digital Filter Plus under Linux, please extract the .tar.gz file into a suitable directory e.g. : */usr/local/Numerix/DFPlus*. This directory can be placed in the path or a shortcut can be created to the executable program (dfplus).

Using Digital Filter Plus Under Linux

In order to open the User's Guide and Update page, under Linux it is necessary for Digital Filter Plus to know what application to use. These are specified in the file `dfplus.ini`, as follows :

```
[LINUX_PDF_PATH]
acroread
```

```
[LINUX_BROWSER_PATH]
firefox
```

If you are using different applications then please modify these entries using a text editor.

p

Using Digital Filter Plus

Digital Filter Plus has the same look and feel when running under Windows or UNIX / Linux.

Starting Digital Filter Plus

When the Digital Filter Plus program is started you will be presented with the project dialog, where it is necessary to select the project name, sample rate and filter type. The dialog looks like this :

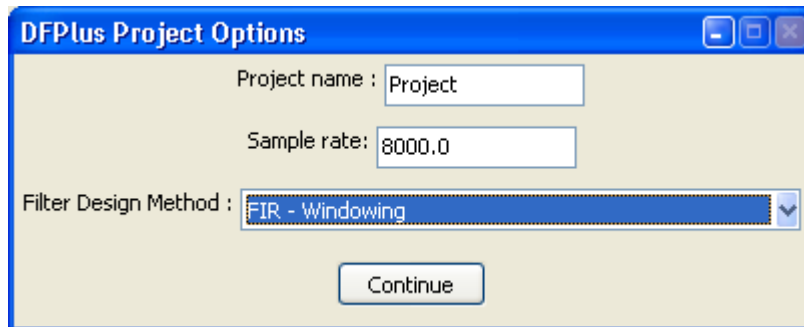

From the “Filter Design Method” drop down box you can choose the type of filter design that you would like to use.

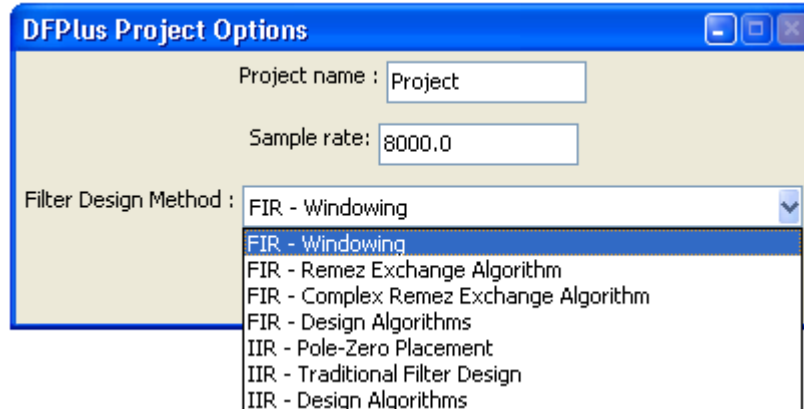

The filter design options are :

FIR - Windowing

FIR - Remez Exchange Algorithm : allows simple LP, HP, BP and notch filters

FIR - Complex Remez Exchange Algorithm : allows more complex designs

FIR - Design Algorithms : Hilbert transformer, Raised cosine, Square root raised cosine and Gaussian designs

IIR Pole Zero Placement

IIR - Traditional Filter Design : Butterworth, Chebyshev, Inverse Chebyshev, Elliptic and Bessel; all using either the bilinear transform or the matched z-transform.

IIR – Design Algorithms : Notch filter.

If you select a project name that is the same as one that you have previously used then you will be prompted to verify that you do wish to overwrite the old project.

Once this dialog has been completed you will be taken to the appropriate filter design module, where you will be able to enter the specification of your desired filter and then you will be able to generate and view the coefficients.

When you execute Digital Filter Plus on future occasions it will remember your previous options.

The Main Digital Filter Plus Design Window

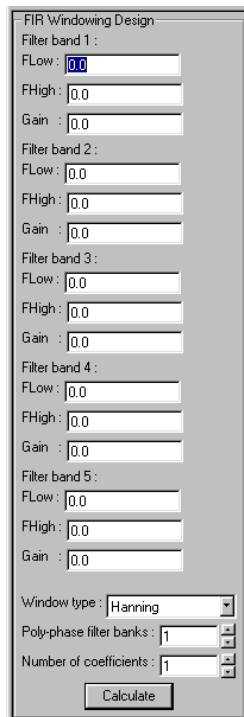

The main design window for Digital Filter Plus is the same for all filter design methods. On the right hand side of the application is the dialog for entering the filter specification. For example the image to the right of this text is the design entry point for designing an FIR filter using the window design technique.

For all filter types you will be required to enter the correct parameters for your chosen filter and then click the calculate button or hit the enter key.

Once the filter coefficients have been calculated Digital Filter Plus will then analyze the time and frequency domain performance of the filter. It will then display a graph of the frequency domain magnitude response. You will be able to change the graph display mode using the pull down box below the graph, as shown below :

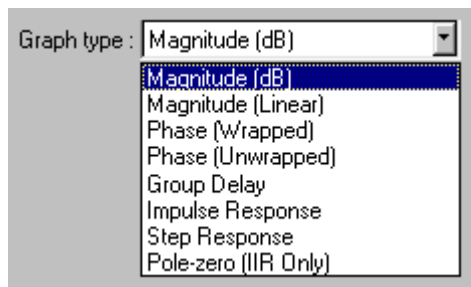

When a graph is displayed it is possible to display the values of the graph by placing the cursor over the graph area and the values are displayed in the status bar at the bottom of the Digital Filter Plus window.

The status bar runs along the bottom of the application window and contains three components. On the left hand side it displays the filter design technique being used. This picture shows the FIR windowing method is being used :



In the middle the status bar displays the X and Y co-ordinates of the graph under the position of the cursor, when a graph is displayed. If the graph is displayed in the time domain, for example the impulse response then the text displays the location in the array and the value associated with it, as shown here :



Location : 180, Value : -55.640057

If the graph displays frequency domain data then the text displays the frequency index and the value associated with it, as shown here :

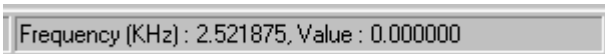

Frequency (KHz) : 2.521875, Value : 0.000000

On the right hand side the status bar displays the application sample rate, as shown below :

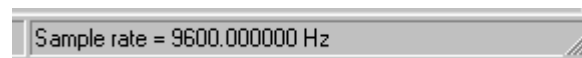

Sample rate = 9600.000000 Hz

Digital Filter Plus Projects And Files

Digital Filter Plus requires a project to be opened before a filter can be designed. The project name will be the base name for all the files that will be stored by the project.

Digital Filter Plus outputs the following files to the current working directory :

- .dfc Digital filter coefficients
- .dfs Digital filter specification
- .dfz z-domain filter specification

As an example, if the default project name of "Project" is used then the output files will be : Project.dfc, Project.dfs and Project.dfz.

The filter coefficients are stored in floating point, Q format (m.n) and fixed point so that they can be incorporated into the source code of the application.

For FIR filters the optional poly-phase filter option will also separate the coefficients into the required number of filter banks in the .dfc file.

The filter coefficients and specification files can be viewed from within the Digital Filter Plus application by using the "View" menu option or they can be viewed with an external file editor.

Toolbar And Menu Options

Digital Filter Plus is controlled from either the menu options or the toolbar buttons.

Toolbar

The toolbar buttons have the following functionality :



Open a new project



View filter coefficients



View filter specification



View z-domain coefficients (for IIR filters only)



Digital Filter Plus Options



View User's Guide



Check for new versions on the web



Enter license key



View version and license information about Digital Filter Plus



Exit Digital Filter Plus

The toolbar is detachable under Linux so that the user can allocate more space to the Graph and status bar.

File Menu

The file menu provides the following two options :

New Project - Returns to the project creation dialog.

Exit - Exits Digital Filter Plus

View Menu

Allows the following information to be viewed from within Digital Filter Plus :

Filter coefficients
Filter specification
z-domain coefficients (for IIR filters only)

This information is provided in text format and the text can be cut and pasted into another application.

Options Menu

The options menu allows the user to modify the following options :

Q Number Format (m.n) – Sets the value of m and n. The maximum value of m+n should be less than or equal to 64. Both m and n must be positive integers greater than or equal to 1.

Graph Scaling – Sets the scaling of the log magnitude graph to allow the magnitude to be zoomed in on the pass-band.

The menu options selected are stored and recalled between sessions.

Help Menu

The help menu contains the following options :

View User's Guide – This option will open up the User's Guide (this document), which is in PDF file format. Please ensure that you have Adobe Acrobat installed on your computer before accessing this function. If you do not have the Acrobat viewer then it can be downloaded for free from <http://www.adobe.com>.

Check for new versions on the web – This option will connect to the Numerix web site. Please ensure that your computer is connected to the Internet before selecting this option.

Enter license key – This option allows a registration key to be entered, in order that DFPlus will save the filter coefficients. If this is an unregistered version of DFPlus then you can contact Numerix Ltd to register it, where upon you will receive a registration code that can be entered into this dialog.

About – This option provides details about the version of Digital Filter Plus that you are using.

Designing Finite Impulse Response - Transversal Digital Filters

Introduction

There are four top level options for designing FIR filters :

FIR - Windowing

FIR - Remez Exchange Algorithm : allows simple LP, HP, BP and notch filters

FIR - Complex Remez Exchange Algorithm : allows more complex designs

FIR - Design Algorithms : Hilbert transformer, Raised cosine, Square root raised cosine and Gaussian designs

For each of the FIR filter design techniques, the maximum number of coefficients allowed in a filter is 1000. All 1000 coefficients are stored in the output file and are used for calculating the frequency domain graphs but the time domain graphs only display the first 512 coefficients. For all options except the "Design Algorithms" option it is also possible to specify a poly-phase configuration for implementing poly-phase multi-rate filters. If the value is set to a value other than 1 then this will generate the requested number of filter banks.

FIR - Windowing

The windowing design section of Digital Filter Plus calculates the coefficients for an arbitrary response with separate gain levels for up to 5 separate frequency ranges. The gain for each stage is specified as a value greater than or equal to zero (zero being total attenuation). Typically, the gain values fall in the range $0 \leq G \leq 1.0$, however larger gain values may be used. When the required response has been entered then the required number of coefficients is entered along with the desired window type and the number of poly-phase filter banks.

FIR - Remez Exchange Algorithm

The Parks-McClellan Remez exchange algorithm designs optimal FIR filters i.e. there is equi-ripple in the pass bands and stop bands. Digital Filter Plus supports two different Remez exchange algorithm techniques - simple and complex. The simple mode allows the design of traditional low-pass, high-pass, band-pass and band-stop (notch) filters. The complex mode allows the design of FIR filters with up to 4 arbitrary frequency bands.

Remez Exchange Algorithm Notes :

The desired gain for each band must be greater than or equal to zero but is usually chosen to be 1.0 for the pass-band(s) and zero for the stop-band(s).

The desired ripple / attenuation weights for each band are specified in dBs so they should always be positive numbers.

For complex filters with a large number of coefficients, this option may take several seconds to converge even on the highest specification of computer.

Simple Remez Exchange Algorithm

This mode allows the options to estimate the filter order before calculating the coefficients. This can be done by clicking the "Estimate Order" button, where upon the estimated order is pushed into the filter order scroll box. This functionality uses the Kaiser approximation. Should the estimated length not be appropriate for the application then the filter order can also be changed manually.

The diagram on the right shows an example of how to use the simple Remez exchange algorithm module to design a filter with the following requirements :

- Sample rate = 9600 Hz
- Filter type = low-pass
- Cut-off frequency = 1200 Hz
- Pass-band ripple = 1.0 dB
- Transition bandwidth = 200 Hz
- Stop-band attenuation = 80 dB

The "Estimate Order" button has been clicked and the estimated filter length is 131 samples. Clicking the Calculate button will now generate the filter coefficients.

FIR Remez Algorithm Design

Filter type : Low pass

Pass band :

Cut-off frequency 1 : 1200

Cut-off frequency 2 : 0.0

Ripple (dB) : 1.0

Transition Band

Bandwidth : 200

Stop band :

Attenuation (dB) : 80.0

Estimate Order

Poly-phase filter banks : 1

Number of coefficients : 131

Calculate

Large filters may take a few seconds to calculate

Complex Remez Exchange Algorithm

You must specify a minimum of two filter bands e.g. a low pass filter has a pass band region and a stop band region. One of the regions must extend to D.C and another must extend to the Nyquist frequency.

The table on the right shows the configuration for designing a low pass filter with two frequency bands and a sample rate of 2 kHz.

Note : Digital Filter Plus will verify the validity of your entries but the frequencies of each band should increase through the Nyquist frequency range. In addition to this requirement, the frequency bands should not overlap.

The screenshot shows the 'FIR Remez Algorithm Design' interface. It contains the following fields and values:

Parameter	Value
Filter band 1 : Flow :	0.0
FHigh :	100
Gain :	1
Ripple / Atten (dB) :	1
Filter band 2 : Flow :	101
FHigh :	1000
Gain :	.1
Ripple / Atten (dB) :	80
Filter band 3 : Flow :	0.0
FHigh :	0.0
Gain :	0.0
Ripple / Atten (dB) :	0.0
Filter band 4 : Flow :	0.0
FHigh :	0.0
Gain :	0.0
Ripple / Atten (dB) :	0.0
Poly-phase filter banks :	1
Number of coefficients :	55

At the bottom of the form is a 'Calculate' button.

FIR - Design Algorithms :

This module allows the design of the following FIR filter types : Hilbert transformer, Raised cosine, Square root raised cosine and Gaussian design.

A Hilbert transformer is a filter that phase shifts all frequencies by 90° the only parameter to specify is the filter length.

For the raised cosine and square root raised cosine it is necessary to specify the symbol rate in Hz and the alpha factor of the filter.

There are two design options for the Gaussian filter : specify the standard deviation of the distribution or the bandwidth. These options can be selected using the radio buttons on the menu.

Designing Infinite Impulse Response - Biquad Digital Filter

Introduction

There are three top level options for designing IIR filters :

FIR – Pole-zero Placement - Place the poles and zeros manually on the z-plane

FIR – Traditional Filter Design - Automatically place the poles and zeros according to the provided specification.

FIR - Design Algorithms : Notch filter designs

In all cases, DFPlus generates conjugate pairs of poles and zeros and incorporates them into a single second order section (biquad). If an odd order filter is selected then the final stage is still implemented as a biquad with $b(2)$ and $a(2)$ both equal to zero. In many cases this provides a more efficient run-time implementation than having a final, additional, first order filter section.

The coefficients for the IIR filter are stored in a linear array, as follows :

stage 1 $b(0), b(1), b(2), a(1), a(2)$

stage 2 $b(0), b(1), b(2), a(1), a(2)$

.

.

stage N $b(0), b(1), b(2), a(1), a(2)$

These would map to the Direct Form II biquad as follows :

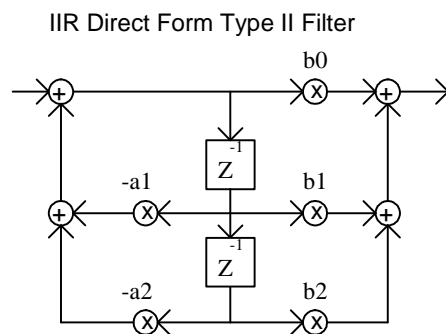

The z -transform for the IIR biquad is as follows :

$$Y(z) = \frac{b(0) + b(1)z^{-1} + b(2)z^{-2}}{1 + a(1)z^{-1} + a(2)z^{-2}} X(z)$$

The format of the coefficients within the output file are compatible with SigLib and Matlab. If your tools do not support this configuration then you will need to negate these coefficients.

IIR - Pole-zero Placement

In the pole / zero placement technique, the poles and zeroes are entered as magnitude and angle, with the magnitude of the poles $0 < |P| < 1$ and the magnitude of the zeros being any positive value. Angles are specified in degrees and can also take any positive value. This technique generates 2nd order biquad sections with complex conjugate poles and zeros.

IIR - Traditional Filter Design

The Traditional IIR filter design algorithms allow the option of four basic filter types :

- Low pass
- High pass
- Band pass
- Band stop / notch

Digital Filter Plus will allow the design of even and odd order Low and High pass filters. If the filter order is odd in length then the filter will generate the next highest even order filter so that the implementation code is more efficient because it does not have to include an additional loop for the final first order section. It will also allow the design of Band pass and Band stop filters that are based around even order prototypes. I.E. the filter orders are multiples of four in length.

Within these types of filter it is possible to specify one of five different design algorithms :

- Butterworth
- Chebyshev
- Inverse Chebyshev
- Elliptic
- Bessel

These design algorithms actually specify analog filter prototypes which must be translated to the digital domain using either of the following transformations :

- Bilinear transform
- Matched z-transform

Each of these transformations has advantages and disadvantages. If you are not familiar with the detailed differences then we would recommend that you start with the bilinear transform.

The band edges requested are listed in increasing order of frequency so for an Elliptic notch filter the following applies :

- Band edge 1 : Pass band 1 edge
- Band edge 2 : Stop band edge 1
- Band edge 3 : Stop band edge 2
- Band edge 4 : Pass band 2 edge

For each filter type, different inputs are required, as follows :

Non Elliptic Filters

Filter order

Does not require the pass band ripple or stop band attenuation

Low pass Band edge 1 - the pass-band cut off frequency

High pass Band edge 1 - the pass-band cut off frequency

Band pass Two frequencies

Band stop Two frequencies

For the Chebyshev and inverse Chebyshev filter types it is necessary to specify the pass band ripple or stop band attenuation level respectively.

Elliptic Filters

Does not require the filter order as this is calculated

Does require the pass band ripple or stop band attenuation

Low pass pass band and stop band cut off

High pass pass band and stop band cut off

Band pass 4 cut offs for the pass band and stop bands

Band stop 4 cut offs for the stop band and pass bands

Pass band gain normalization

Within the filter specification table it is also possible to select the algorithm to normalise the pass-band gain of the filter. This "0 dB pass-band scaling tick box" forces the filter gain to be 0 dB at the following frequencies :

Low pass 0 Hz

High pass The Nyquist frequency

Band pass The pass-band centre frequency

Band stop 0 Hz

This gain normalization is performed independently on each biquad so as to reduce the problems of numerical scaling and overflow as far as possible.

Bilinear Transform Pre-warping

Digital Filter Plus supports optional pre-warping of the frequency axis for use with the bilinear transform. If you are not familiar with this issue then we would recommend that you leave it enabled.

Band pass and band stop (notch) filters

Band pass and band stop (notch) filters use combinations of low pass and high pass filters to achieve the required specifications and hence the final size will always be twice the order specified and the filter orders will range from 4 to 32. For example, if a filter order of 12 is specified then the filter generated will actually be of 24th order.

The diagram on the right shows an example of how to use the traditional IIR filter design algorithms to design a filter with the following requirements :

Sample rate = 9600 Hz

Filter type = low-pass
Butterworth

Analog to digital transform = Bilinear

Cut-off frequency = 1200 Hz

Filter order = 12

0 dB Passband scaling = Enabled

Pre-warping = Enabled

Clicking the Calculate button will now generate the filter coefficients.

Traditional IIR Filter Design

Filter type : Low pass

Design Method : Butterworth

Translation type : Bilinear Transform

Band Edge 1 : 1200.0

Band Edge 2 : 0.0

Band Edge 3 : 0.0

Band Edge 4 : 0.0

Pass-band Ripple (dB) : 0.0

Stop-band Atten. (dB) : 0.0

Filter order : 12

0 dB Passband scaling : Enable

Pre-warping : Enable

Calculate

IIR – Design Algorithms

This module allows the design of the following IIR filter types : Notch filter.

The notch (band-stop) filter option designs IIR filters where the zeros are placed on the unit circle at the specified frequency and the poles are at the same frequency (θ) but located at the given magnitude (M) within the unit circle, as shown in the following diagram.

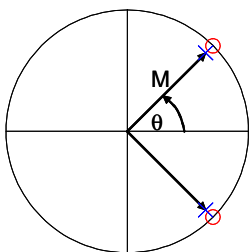

Regardless of the filter order, all of the poles are placed at the same location and the same is also true for all of the zeros. This technique generates 2nd order biquad sections with complex conjugate poles and zeros.

The filter entry dialog allows the specification of the notch centre frequency and the magnitude of the pole, as shown in the following diagram :

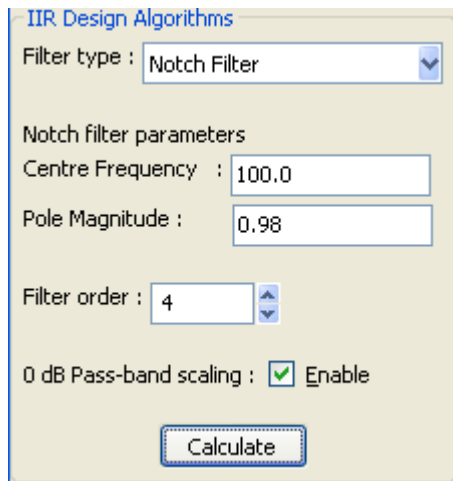

The "0 dB pass-band scaling tick box" scales the 0dB level as follows :

Location Of Notch	Scaling Frequency
\leq (sampling frequency / 4)	Nyquist frequency
$>$ (sampling frequency / 4)	0 Hz

Registration

The registered and un-registered copies of Digital Filter Plus are the same however a registered copy will allow DFPlus to save the calculated filter coefficients to a file on a disk.

If you have received a registration key from Numerix Ltd. then DFPlus can be registered using the "Help | Enter license key" menu option.

Technical Support

For technical support, please contact us at : support@numerix-dsp.com.

Digital Filter Plus, DFPlus and SigLib are trademarks of Numerix Ltd.

Windows is a Registered Trademark of Microsoft Corp. USA and Linux is a registered trademark of Linus Torvalds.